

NON-LINEAR DIGITAL AUDIO PROCESSOR FOR DEDICATED LOUDSPEAKER SYSTEMS

A. Bellini¹, G. Cibelli¹, E. Ugolotti², A. Farina³ and C. Morandi¹

¹DII—Università di Parma, Viale delle Scienze, 43100 Parma, Italy

²ASK Industries S.p.A., via F.lli Cervi, 79, 42100, Reggio Emilia, Italy

³Dipartimento di Ingegneria Industriale - Università di Parma

Abstract— In this paper a non-linear loudspeaker model, which accurately reproduces the low frequency behavior, is presented. This description, derived from an extension of the well known Small-Thiele equations, requires far less computational time and memory space than generic non linear structures. Moreover a noticeable further reduction of the number of operations and of the memory cells required has been achieved by means of a multirate architecture. Inversion of the proposed model allows digital prefiltering of the electrical signal in order to compensate for the non idealities of the electro-acoustic conversion. The above filter structure implemented on a digital signal processor, placed between the audio signal source and the power amplifier allows effective compensation of loudspeaker linear (both magnitude and phase) and non linear distortion. Measurement results obtained with a commercial woofer are discussed.

I. Introduction

Voice coil loudspeakers, the most used audio transduction devices, produce an acoustic field in the air as a result of the action of an electric signal.

The current driven by the audio amplifier flows in the coil, moving in constant magnetic field, and produces an axial force on the cone, which is tied to the coil. In an ideal system the relationship between input (electric variables), and output (acoustic variables) would be a linear one. Unfortunately, the magnetic field is not constant as the cone is displaced from its equilibrium position and the reaction force arising from the cone suspension is non-linear with the displacement.

These effects result in a deterioration of the emitted sound that can become even intolerable. Therefore, an audio signal processor can be inserted before the power amplifier and the loudspeaker, with the purpose of adjusting the signal so that the overall transducer chain is linear. For simplicity in the following sections the power amplifier will be considered strictly linear. Moreover the case of a loudspeaker mounted on a virtually infinite baffle will be assumed.

Preliminary audio processor implementations aiming at a reduction of distortion are already described in literature following either a closed-loop or an open loop control approach [1], [2], [3], the latter being possible

only thanks to the availability of accurate loudspeaker models. The field is extensively studied in the literature [4], [5], but to the best of our knowledge, the available models rely on measurement results rather than on first principles and construction parameters.

II. Loudspeaker non-linear modeling

Until now loudspeakers have been modeled, following the well-known Small-Thiele approach [6], that describes their behavior at low frequencies and small input power, and produces a linear transfer function. Unfortunately it does not match our requirements; first of all because it is a linear model and moreover as it does not describe accurately real Sound Pressure Level (SPL) curves. In order to describe non linear systems some general structures have been presented in literature [7], [8], [9], [10]. Among them, the Volterra series expansion [4] seems useful for describing weak non-linearities. In parallel with the linear block, quadratic, cubic, and higher order blocks are considered and connected as shown in fig. 1. Due to the great number of operations required, this structure cannot be adopted for real time applications.

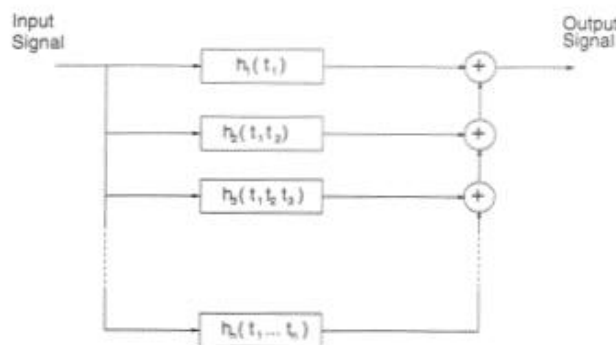

Fig. 1. Block diagram of Volterra series expansion.

The proposed model is based on the Small-Thiele description of the electro-mechano-acoustic equivalent system reported fig. 2.

The circuit elements in Fig. 2 can be computed directly from the Small-Thiele parameters measured by

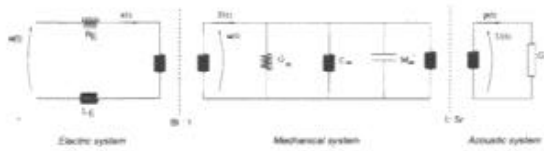

Fig. 2. Acoustic-side equivalent circuit for a generalized loudspeaker system.

the manufacturer [6].

According to this approach direct-radiation loudspeakers can be modeled at first using lumped-parameters equivalent circuits for the electric, mechanical and acoustic parts of the transducer. In fact the mechanical and the acoustic parts of the loudspeaker are characterized by physical laws formally similar to those of electric circuits, and therefore it is possible to represent a mechanical/acoustic system with an equivalent electric circuit.

- The linear electric circuit, representing the coil can be fully described in terms of the voltage at the coil terminals $e(t)$, and of the current $i(t)$ flowing in the coil, which is limited by the wire resistance R_E , by the coil inductance L_E , and the by the emf at the primary of the transformer, which represents the transduction into electric quantities (voltage and current) of the mechanical quantities (force and speed) available at the transformer's secondary.
- The linear mechanical system can be fully described in terms of the force $F(t)$, acting on the coil-cone assembly, and of the cone's velocity $u(t) = \dot{x}(t)$, the dynamic behavior being determined by the viscous resistance $R_m = G_m^{-1}$, the compliance $K = C_m^{-1}$ of the elastic suspension system, the inertial mass M_m , and by the presence of a transformer primary, representing the transduction into mechanical quantities (force and cone's velocity) of acoustical quantities (pressure and volume air velocity), at the transformer's secondary.
- The acoustic system can be fully described in terms of the volume air velocity $U(t)$, of the acoustic pressure $p(t)$ in front of the loudspeaker, and of the load represented by the air in front of the loudspeaker, which can be linearly modeled by $G_a(t)$, which is the response, in terms of volume air velocity, to the unity pressure pulse $\delta(t)$.

This can be formally expressed with the following equation set

$$Bl i(t) = F(t) \tag{1}$$

$$e(t) - R_e i(t) - L \frac{di(t)}{dt} = Bl \dot{x}(t) \tag{2}$$

$$U(t) = S_r \dot{x}(t) \tag{3}$$

$$F(t) - R_m \dot{x}(t) - M_m \ddot{x} - Kx = p(t)S_r \tag{4}$$

$$U(t) = G_a(t) * p(t) \tag{5}$$

where S_r is the effective radiating surface, Bl is the force factor of the magnetic field, and the symbol $*$ stands for the convolution operator. Let ρ_0 be the air density, c_s the sound velocity in the air, supposed constant, and r_a the radius of the effective radiating surface of the loudspeaker, $S_r = \pi r_a^2$. At low frequencies we can assume the expression of $Z_a(s)$ reported by [11]:

$$Z_a(s) \triangleq \frac{1}{G_a}(s) = -\frac{\rho_0}{2\pi c_s} s^2 + \frac{8\rho_0}{3\pi^2 r_a} s \tag{6}$$

In order to define a non-linear woofer model suitable for a simple inversion and implementation on a low cost DSP [12], we rewrite the above Small-Thiele equations, pointing out the dependence of the force factor $Bl = Bl(x)$, of the suspension stiffness $K = K(x)$ and, eventually of the coil inductance $L = L(x)$ (that can usually be neglected at low frequencies) from the instantaneous cone displacement $x(t)$. The following relations are thus obtained:

$$Bl(x)i(t) = F(t) \tag{7}$$

$$e(t) - R_e i(t) - L(x) \frac{di(t)}{dt} = Bl(x) \dot{x}(t) \tag{8}$$

$$U(t) = S_r \dot{x}(t) \tag{9}$$

$$F(t) - R_m \dot{x}(t) - M_m \ddot{x} - K(x)x = p(t)S_r \tag{10}$$

$$U(t) = G_a(t) * p(t) \tag{11}$$

From equations 9 and 11, by Laplace transformation

$$U(s) = S_r s \mathbf{x}(s) = G_a(s) \mathbf{p}(s)$$

that yields:

$$\mathbf{p}(s) = Z_a(s) S_r s \mathbf{x}(s) \tag{12}$$

where $Z_a(s)$ is the acoustic impedance, representing the load.

Given a set of n fixed displacements \hat{x}_n , we can approximate $Bl(x)$, $K(x)$ and eventually $L(x)$, respectively with $Bl(\hat{x}_n)$, $K(\hat{x}_n)$ and $L(\hat{x}_n)$ in order to linearize the above equations near \hat{x}_n .

Inserting equations (12) and (7) into (10) and taking the Laplace transforms, we obtain

$$Bl(\hat{x}_n) \mathbf{i}(s) - K(\hat{x}_n) \mathbf{x}(s) = \mathbf{J}(s) \mathbf{x}(s) \tag{13}$$

where:

$$\mathbf{J}(s) = s^2 M_m + s R_m + s S_r \mathbf{Z}_a(s) \quad (14)$$

Moreover, from equation (8):

$$\mathbf{e}(s) = [R_e + L(\hat{x}_n)s] \mathbf{i}(s) + Bl(\hat{x}_n) s \mathbf{x}(s) \quad (15)$$

and then

$$\mathbf{i}(s) = \frac{\mathbf{e}(s) - Bl(\hat{x}_n) s \mathbf{x}(s)}{R_e + L(\hat{x}_n) s} \quad (16)$$

From (13) and (16) we derive:

$$\frac{Bl(\hat{x}_n) \mathbf{e}(s)}{R_e + L(\hat{x}_n) s} = \left[K(\hat{x}_n) + \mathbf{J}(s) \mathbf{x}(s) \frac{Bl^2(\hat{x}_n) s}{R_e + L(\hat{x}_n) s} \right] \mathbf{x}(s)$$

Hence it is possible to define the system transfer function for small variations near $x = \hat{x}_n$

$$\varphi_{\hat{x}_n}(s) = \frac{\mathbf{p}(s)}{\mathbf{e}(s)} \Big|_{x=\hat{x}_n} \quad (17)$$

This leads to the definition of a set of expressions describing the loudspeaker behavior with respect to its instantaneous displacement.

$$\varphi_{\hat{x}_n}(s) = \frac{\mathbf{Z}_a(s) \mathbf{S}_r(s) s Bl(\hat{x}_n)}{R_e + s L(\hat{x}_n)} \left[K(\hat{x}_n) + \frac{Bl^2(\hat{x}_n) s}{R_e + s L(\hat{x}_n)} + \mathbf{J}(s) \right]^{-1}$$

From the knowledge of the cone instantaneous displacement, or an approximation of it, as a function of the input signal, we can fully describe the loudspeaker behavior. This could be obtained in principles by a linear approximation, i.e. by a transfer function $\mathbf{H}(s)$ producing the actual displacement as a function of the audio electric input $e(t)$.

A first loudspeaker model, based on this approximation is represented by the block diagram of fig. 3.

Unfortunately, the five equations, (1), (2), (3), (4), (5), of the small-signal Small-Thiele model do not describe faithfully SPL curves, that, on the other hand, can be accurately measured. SPL curves, which are obtained by measuring in an anechoic room the response of the loudspeaker when it is excited with pure sinusoidal tones, provide the true system transfer function $\varphi_0(s) = \frac{\mathbf{p}(s)}{\mathbf{e}(s)}$, measured under linear working conditions.

Therefore we propose to derive from the set of relations $\varphi_{\hat{x}_n}(s)$ only the informations concerning the non

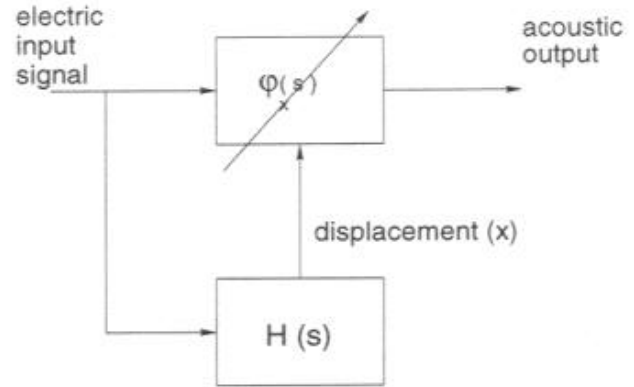

Fig. 3. Block diagram of the first loudspeaker model.

linear behavior, that means, the variations with respect to $\varphi_0(s)$, and to use for $\varphi_0(s)$ the transfer function derived from SPL measurements.

Let us define the function

$$\psi_{\hat{x}_n}(s) \triangleq \frac{\varphi_{\hat{x}_n}(s)}{\varphi_0(s)} \quad (18)$$

that describes the non linear distortions caused by the variation of parameters at different displacements. Then, a linear filter in cascade with the previous system can take into account the small signal behavior. We obtain the model sketched in fig. 4.

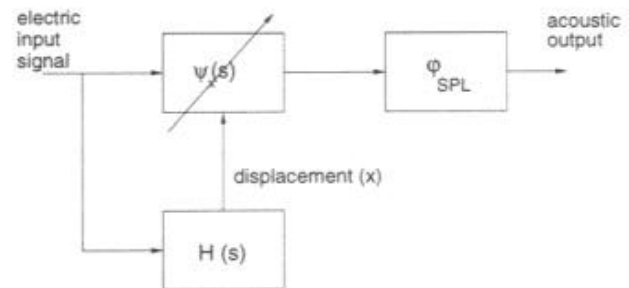

Fig. 4. Block diagram of the second loudspeaker model.

The proposed model works fine within the whole audio spectrum, if properly adjusted to a particular loudspeaker. To this purpose the Small-Thiele parameters and the measured SPL curves are needed. Moreover the profiles of $Bl(x)$, $K(x)$, $L(x)$ and H must be known. It must be pointed out that while the latter proves to be critical (its derivation will be discussed in the following section) a rough approximation of $Bl(x)$ and of $K(x)$ is sufficient, and $L(x)$ is not relevant for woofers. An acceptable approximation is

$$\begin{aligned}
 Bl(x) &= Bl(0) \left[\alpha \left(\frac{x}{x_{max}} \right)^2 + \beta \frac{x}{x_{max}} + 1 \right] \\
 K(x) &= K(0) \left[\gamma \left(\frac{x}{x_{max}} \right)^2 + \delta \frac{x}{x_{max}} + 1 \right]
 \end{aligned}
 \tag{19}$$

where $\alpha < 0$, $\gamma > 0$ express the fractional reduction of the magnetic field and the increase of the suspension stiffness respectively, and x_{max} stands for the maximum displacement at nominal input power. The coefficients β and δ account for non symmetrical profiles.

A. Weakly non linear working mode

As mentioned in the previous section a linear filter $H(s) = \frac{x(s)}{e(s)}$ is required in order to estimate as accurately as possible, the instantaneous displacement of the driver $x(t)$, given the electric audio signal $e(t)$. Unfortunately, all the nonlinearities caused by the variations of $Bl(x)$, $K(x)$, $L(x)$, (see equations (7), (8), (9), (10), (11)) affect the position of the cone. Anyway, we shall suppose to be in the case of small non-linearities, so that an appropriate linear filter can produce an output signal resembling the driver displacement. It must be noted that any error in the phase response of the synthesized filter produces a delay (positive or negative) between the real and the calculated position of the cone causing a remarkable deterioration of the proposed model.

A few solutions to compute \mathbf{H} were examined, but none of them was completely satisfactory. First of all, an expression of \mathbf{H} can be obtained directly from the linear model:

$$\mathbf{H}_x(s) = \frac{Bl(\bar{x})}{R_e + sL(\bar{x})} \left[K(\bar{x}) + \frac{Bl^2(\bar{x})s}{R_e + sL(\bar{x})} + \mathbf{J}(s) \right]^{-1} \tag{20}$$

where a suitable value of \bar{x} , that might be different from zero, be determined while adjusting the model. The amplitude and the phase of the filter obtained with this approach are reported in figs. 5 and 6 respectively.

Unfortunately, this solution proved to be non effective on a wide frequency range.

An alternative solution consists of dividing both terms of equation 12 by $e(s)$, so as to obtain:

$$\frac{\mathbf{p}(s)}{e(s)} = \mathbf{Z}_a(s)S_r s \frac{x(s)}{e(s)} \triangleq \mathbf{Z}_a(s)S_r s \mathbf{H}_x(s) \tag{21}$$

Thus it is possible to derive an expression of \mathbf{H} from the transfer function $\frac{\mathbf{p}(s)}{e(s)}$ directly measured from the SPL. We shall hereafter denote the transfer function $\frac{\mathbf{p}(s)}{e(s)}$, obtained by SPL measurements, by ϕ_{SPL} , rather than ϕ_0 . The amplitude and the phase of the filter

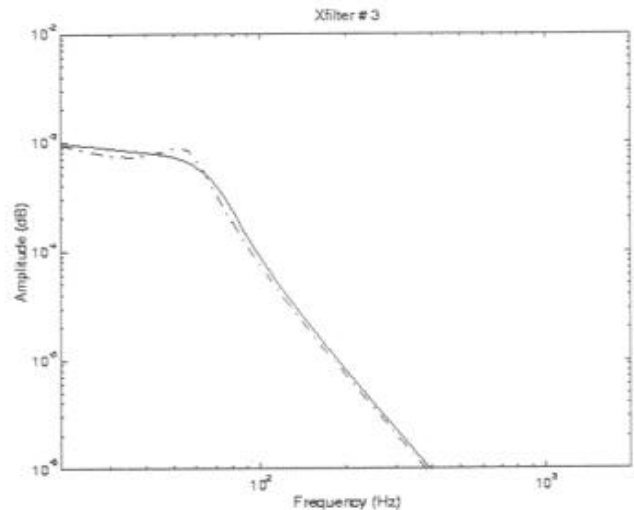

Fig. 5. Magnitude of H_x filter from Small-Thiele model. (ideal: dashed line ; FIR implemented on DSP: solid line)

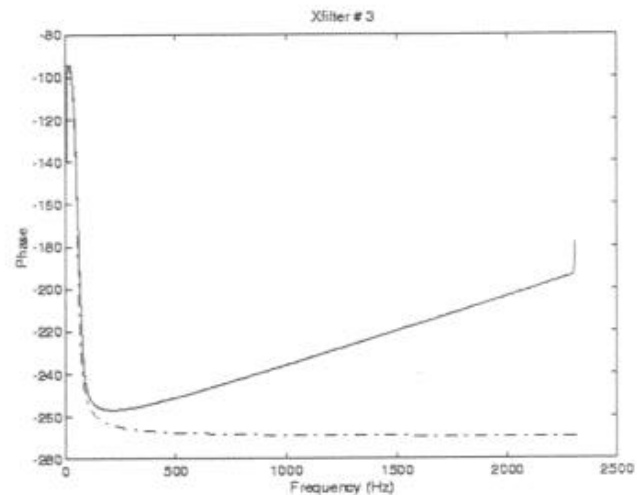

Fig. 6. Phase of H_x filter from Small-Thiele model. (ideal: dashed line ; FIR implemented on DSP: solid line)

obtained with this approach are reported in figs. 7 and 8 respectively.

A third option which was not applied due to the unavailability of the required instruments, is represented by the direct measure of $\mathbf{H}(s)$: from this, a noteworthy increase of performance can be expected.

B. Highly non linear working mode

In the above section it has been assumed the hypothesis of weak nonlinear distortion. Nevertheless at very low frequencies and high input power the THD reaches peaks near 100%. In these conditions the loudspeaker is not able to reproduce pleasant sounds and almost the whole input power is shifted on higher harmonic tones.

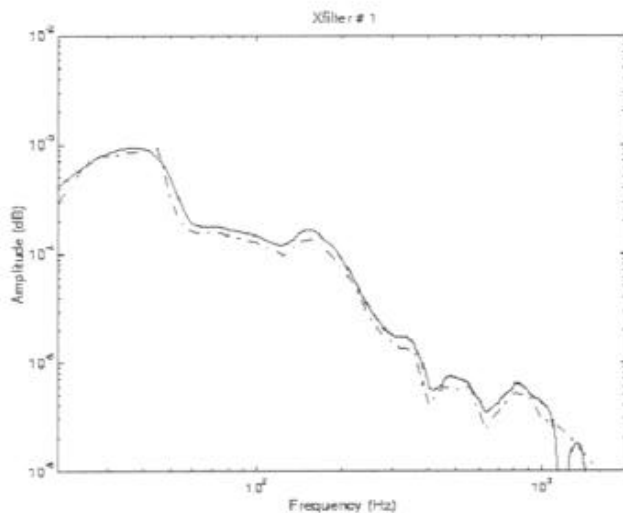

Fig. 7. Magnitude of H_x filter from SPL measurements. (ideal: dashed line ; FIR implemented on DSP: solid line)

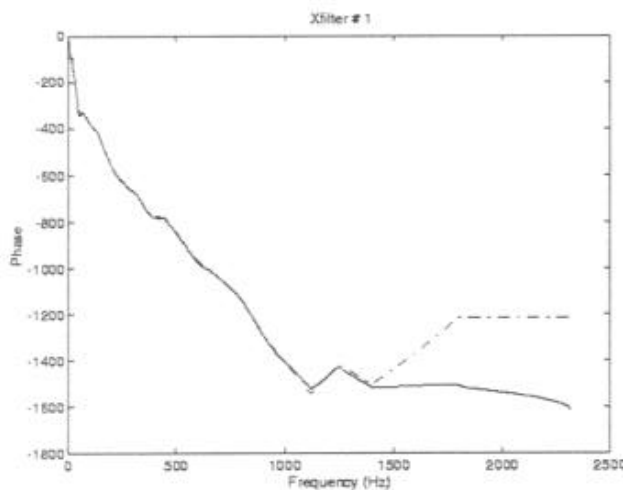

Fig. 8. Phase of H_x filter from SPL measurements. (ideal: dashed line ; FIR implemented on DSP: solid line)

The braking effect due to the decrease of the magnetic field and to the increase of the suspension stiffness should be counteracted with an higher input power at high displacements. Unfortunately this would cause, at least for the loudspeaker at our disposal, clamping, plastic effects on the cone suspension and even the destruction of the loudspeaker itself. Thus, under these conditions, it is neither possible nor useful to perform any kind of correction.

It is, in such cases, convenient to insert an input high-pass filter to be activated only for high gains of the power amplifier. This helps the system to avoid such unacceptable distortion conditions.

Thus, better reliability is achieved, since clamping and loudspeaker self destruction is prevented, and a

further reduction of nonlinearities by a non-linear processing is allowed anytime.

III. Digital processor for loudspeaker systems

The inversion of the model described in the previous section and sketched in fig. 4, allows to design and implement, using a low cost DSP, a digital audio processor capable to reduce both linear and non-linear loudspeaker distortion. The processor must be inserted within the audio chain, before the power amplifier but necessarily after the volume gain control of the pre-amplifier. In fact, the exact amplitude of the signal applied to the loudspeaker must be known, as this is related to the position of the cone. Fortunately, although all elements following the processor must have a constant and known gain, a good tolerance is accepted. As previously discussed, the loudspeaker can be modeled by means of a linear law whenever it works within small displacements near \hat{x}_n . This relation can be inverted to obtain the inverse filter of fig. 9, where all filters are considered as a function the index n . In fact, digital filters [13], [14] are used, rather than continuous-time filter, since the system is implemented on a DSP.



Fig. 9. Block diagram of an inverse filter effective for small displacements near an equilibrium position.

According to the theory, the Φ_{SPL}^{-1} and $\psi_{x_n}^{-1}(n)$ filters are designed so as to invert the direct Φ_{SPL} measure and $\psi_{x_n}(n)$ respectively:

$$\psi_{x_n}^{-1}(s) \triangleq \frac{\varphi_0^\wedge(s)}{\varphi_{x_n}^\wedge(s)} \quad (22)$$

An estimate of the cone position \hat{x}_n , derived from the signal directly applied to the loudspeaker, is required for processing each input signal sample with the proper filter. A possible approach is to neglect the last sample of the audio signal, which cannot be calculated before choosing the corresponding filter. Another option is to neglect the non-linear part of the model, while deriving \hat{x}_n . In this latter case, the input node of the \mathbf{H} block is connected directly to the output of the equalizing filter Φ_{SPL}^{-1} . In fact, under the hypothesis of weak non-linearity, the correction operated by the $\psi_{x_n}^{-1}(n)$ set of filters will result reasonably small. This choice corresponds to the block diagram of fig. 10.

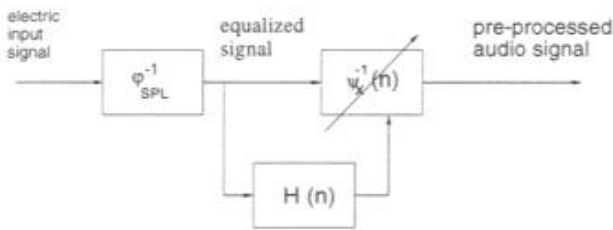

Fig. 10. Block diagram of the inverse filter.

It is easy to understand that the error thus introduced is, in the worst case, as large as the one introduced by deriving the driver displacement through a linear filter \mathbf{H} , driven by the input signal ϵ . In fact, in this latter case all loudspeaker non-linearities would be neglected, while only those corresponding to the correction system are neglected in the proposed filter.

A. On chip implementation

The direct implementation of the structure proposed in fig. 10 would require a computational cost far too high to be implemented on a low cost DSP. Therefore a multirate structure was designed, where low frequency components are decimated and processed at a lower bit rate, while the other components are operated by filters that do not require the compelling constraints, necessary at very low frequencies. Thus the whole system of fig. 11 has been implemented on a 320C542 Digital Signal Processor with only 10 Kword of on chip Dual Access RAM and no other external memory (this being the major limitation).

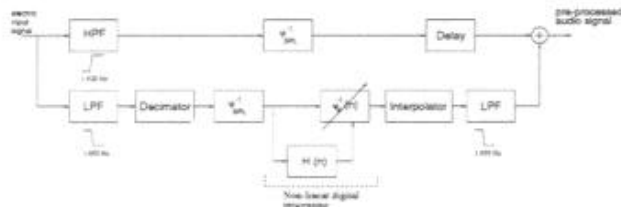

Fig. 11. Multirate non linear processor.

IV. Results

For the experiments a commercial double coil subwoofer with a radiant surface diameter of 110 mm was used. It has an operating frequency range of [20Hz, 2kHz]. A high-precision audio analyzer [15] was used to evaluate the Total Harmonic Distortion (THD) and the Sound Pressure Level (SPL) produced by the loudspeaker. Measurements were performed in an anechoic room with a highly linear microphone, while stimulating the system with pure sinusoidal tones. A remarkable flattening of the amplitude, fig. 12, and a linearization of the phase (fig. 13) of the reproduced SPL has

been achieved. It must be noted the reduction of SPL at very low frequencies is produced by the anti-aliasing filters of the low-quality ADC used.

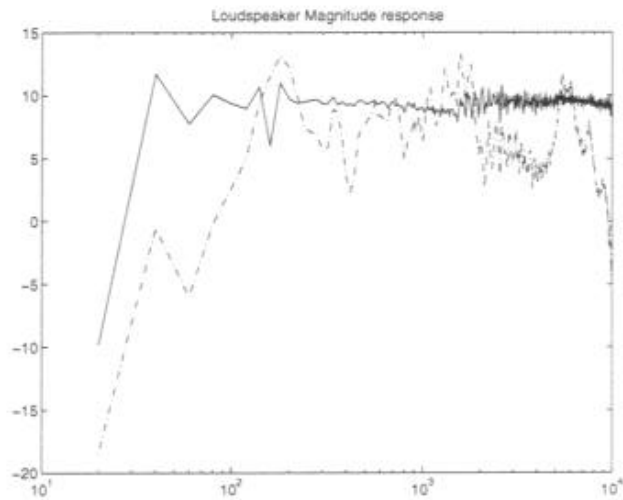

Fig. 12. Comparison between the SPL (amplitude) of the considered loudspeaker with (solid line) and without (dashed line) the audio processor (3 Volt input signal amplitude).

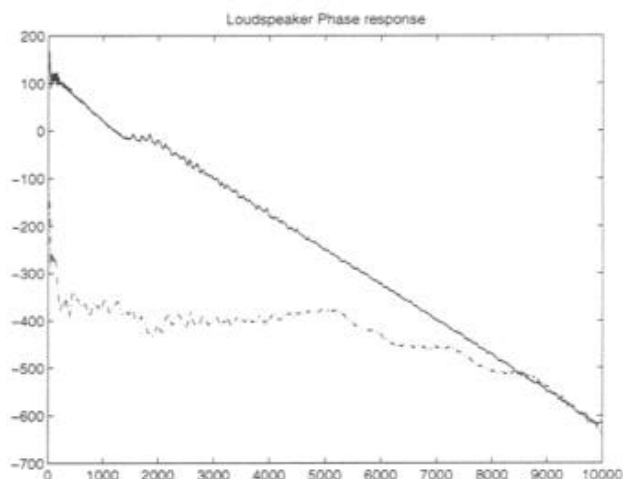

Fig. 13. Comparison between the SPL (phase) of the considered loudspeaker with (solid line) and without (dashed line) the audio processor (3 Volt input signal amplitude).

Moreover harmonic distortion is reduced as shown in figs. 14 and 15 over the frequency range of [20Hz, 90Hz] and for each input power. At higher frequencies the processor is substantially linear. Of course the reduction of harmonic distortion corresponds to equal values of SPL. Distortion was measured by a Brüel and Kjær audio analyzer [15].

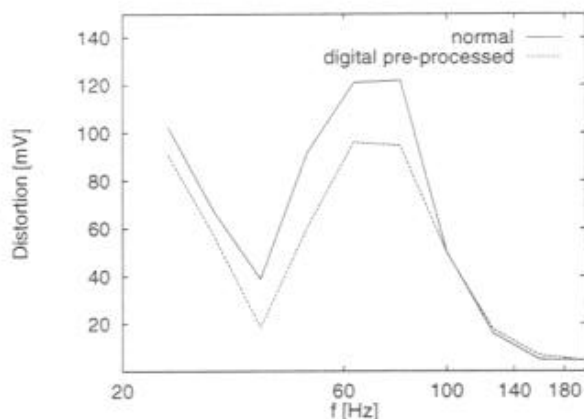

Fig. 14. Comparison between the THD of the considered loudspeaker with and without the audio processor (3 Volt input signal amplitude).

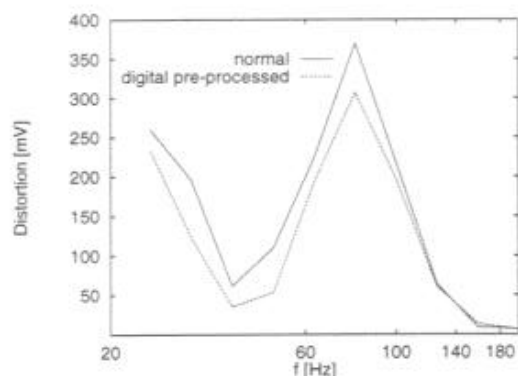

Fig. 15. Comparison between the THD of the considered loudspeaker with and without the audio processor (5 Volt input signal amplitude).

V. Conclusions

A non-linear loudspeaker model, which reproduces the low frequency behavior with good approximation is presented. It was inverted and approximated in order to allow the realization of an anti-distortion audio processor based on a 320C542 Digital Signal Processor.

Measurements performed on the audio signal with and without the insertion of the designed audio processor demonstrate that the audio processor features better performances in the reproduced sound together with higher reliability.

VI. Acknowledgments

The authors would like to thank Ing. Gino Gobbi and the Technical Staff of ASK Industries, for their encouragements and suggestions. The authors would also like to thank Ing. Massimo Martelli of Texas Instruments for the support provided through the TI University Programme.

References

- [1] W. Klippel, "The mirror filter—a new basis for reducing non-linear distortion and equalizing response in woofer systems," *Journal of the Audio Engineering Society*, vol. 40, pp. 675–691, September 1992.
- [2] W. Klippel, "Compensation for nonlinear distortion of horn loudspeakers by digital signal processing," *Journal of the Audio Engineering Society*, vol. 44, pp. 964–972, November 1996.
- [3] A. Bellini, C. Morandi, and E. Ugolotti, "Analog fuzzy audio processor for loudspeaker systems," in *FUZZ IEEE'98*, (Anchorage, Alaska, USA), pp. 1–6, May 1998.
- [4] A. Kaizer, "Modeling of the nonlinear response of an electrodynamic loudspeaker by a Volterra series expansion," *Journal of the Audio Engineering Society*, vol. 35, pp. 421–433, June 1987.
- [5] W. Klippel, "Dynamic measurement and interpretation of the nonlinear parameters of electrodynamic loudspeakers," *Journal of the Audio Engineering Society*, vol. 38, pp. 944–955, December 1972.
- [6] R. Small, "Direct loudspeaker system analysis," *Journal of the Audio Engineering Society*, vol. 20, pp. 383–395, June 1972.
- [7] R. Flake, "Volterra series representation of nonlinear systems," *IEEE Trans. Appl. Ind.*, vol. 81, pp. 330–335, 1963.
- [8] M. F. et al., "An algebraic approach to nonlinear functional expansions," *IEEE Trans. Circuits and Systems*, vol. CAS-30, p. 554, Aug 1983.
- [9] H. Smets, "Analysis and synthesis of non-linear systems," *Trans. IRE.*, vol. CT-7, pp. 459–469, 1960.
- [10] M. Liou, "Nonlinear-system analysis and synthesis," tech. rep., Stanford Electronics Labs., System Theory Labs., Stanford, CA, 1963.
- [11] L. Beranek, *Acoustics*. New York: McGraw-Hill, 1954.
- [12] A. Bellini, G. Cibelli, E. Ugolotti, A. Farina, and C. Morandi, "Non-linear digital audio processor for dedicated loudspeaker systems," in *Proc. of International IEEE Conference on Consumer Electronics*, (Los Angeles), June 1998.
- [13] S.K.Mitra and J.F.Kaiser, *Handbook of digital signal processing*. New-York: McGraw-Hill, 1993.
- [14] A.V.Oppenheim and R.W.Schafer, *Digital signal processing*. Englewood Cliffs,NJ: Prentice-Hill, 1975.
- [15] Brüel and Kjær, Naerum, Denmark, *2012 Audio Analyser Manual*.



Alberto Bellini was born in Forlì, Italy, on December 18, 1969. He received the Dr. Eng. degree in electrical engineering in 1994 at the University of Bologna, Italy and the Ph.D in Electronics and Computer Science from the same University in 1998. Since 1997 he is at the Electronics Dept. of the University of Parma. His current research interests include Digital Signal Processing and non-linear modeling and control of complex systems, and algorithms for fuzzy and neural systems.



Gianfranco Cibelli was born in Reggio Emilia, Italy, on August 3, 1973. He received the Dr. Eng. degree in Electrical Engineering at the University of Parma in April 1998. He is currently working at the same University on non-linear systems modeling. His research interests include signal processing and acoustics.



Emanuele Ugolotti received a Degree (Laurea) in Electronic Engineering from the University of Parma in 1992, with a final thesis work on physical modeling and practical implementation of electromagnetic brake for high power loudspeakers. Since then he was employed in R.C.F. S.P.A., where he designed electroacoustical transducers, especially compression drivers, horns and electronic sound processors as well. In January 1996 he moved

to ASK automotive industries GROUP, as electroacoustics researcher. His current research interests are in the fields of on car interior sounding, in order to optimize the transducers-environment linking, and to optimize the sound field conformation. He currently works in designing active subwoofers for first equipment car application, studying electronic correction of loudspeaker's performance and in sound car interior simulating by means of both auralization technique and boundary elements approach.



Angelo Farina received the engineering degree at University of Bologna in 1982. Ph.D in Technical Physics at University of Bologna in 1987. Researcher at the University of Bologna since 1 November 1986 and at the University of Parma since 1 march 1992 Member of the Audio Engineering Society. His main research activity is Acoustics. In more details: concert halls, musical instruments, subjective preference, auralization, numerical models for

large rooms (pyramid tracing), small cavities (finite elements) and outdoors (image sources). Advanced measurement techniques including sound intensity, MLS, modal analysis, digital recording.



Carlo Morandi got the Doctor degree in Electronic Engineering from the University of Bologna in 1971. Until 1986 he worked with the University of Bologna, D.E.I.S., first as research assistant and later as an associate professor of Electronic Instrumentation. In 1986 he became full professor of Applied Electronics at the University of Ancona, and in 1988 he moved to the chair of Applied Electronics at the University of Parma. The scope of his research

interests gradually broadened from the electrical characterization of semiconductor test structures and devices (MOS capacitors, CCDs, EPROM cells) to the problems of VLSI reliability and testing (fault modeling, electron beam guided failure analysis) and to more general problems of instrumentation, with application in industry and in the biomedical field. He has authored or coauthored more than 100 technical papers on international journals and conference proceedings.